

Data Sheet



Article number: 0125057

Description: Retaining ring SP40
Spring steel

Measures

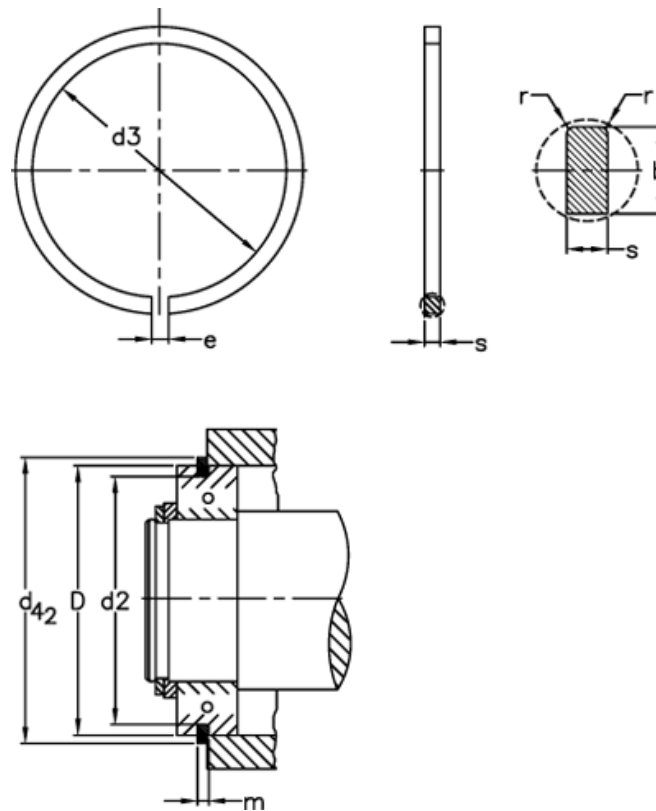

b	= 3.25	FRg kN	= 2.50	tol	= -0.15
D	= 40	FR kN	= 13.5	tol	= -0.1
d2	= 38.10	g	= 2.0	tol	= -0.25
d3	= 37.3	K kN-mm	= 24.2	tol	= 0.3
d42	= 44.6	m	= 1.35	tol	= 0.4
Description	= SP 40	n abl x 1000	= 8.0	Weight kg/1000	= 3.6
e	= 3	r min	= 0.4		
FN kN	= 19.3	s	= 1.12		